

Exponentially Distributed Random Access in LTE-A networks

Rashid Ali

*School of Intelligent Mechatronics Engineering
Sejong University
Seoul, South Korea
rashidali@sejong.ac.kr*

Sung Won Kim

*dept. of Information and Communication Engineering
Yeungnam University
Gyeongsan-si, South Korea
swon@yu.ac.kr*

Zulqarnain

*dept. of Information and Communication Engineering
Yeungnam University
Gyeongsan-si, South Korea
zulqarnain@ynu.ac.kr*

Hyung Seok Kim*

*School of Intelligent Mechatronics Engineering
Sejong University
Seoul, South Korea
hyungkim@sejong.ac.kr*

Abstract—To sustain dense user equipment (UE) deployments, one of the difficult issues is to provide a proficient way to various channel access in the cellular communication networks, such as long-term evolution-Advanced (LTE-A) networks. In LTE-A, random access (RA) is the necessary process to set up the wireless connection between a UE and an evolved node B (eNB). The performance of the RA straightforwardly influences the performance of the whole system. Currently, a discrete uniform distribution (DUD) is used to avoid the potential collision in the network, while multiple UEs try to access the channel resources. However, in a DUD, every UE has an equal chance to choose similar contention preamble near to the expected value of the DUD, which may cause an increase in a collision among the UEs. In this work, we propose a method based on the existing alternatives, such as continuous exponential distribution (CED). CED distributes the random values between two bounds in a poison point process, in which random variables occur continuously and independently with a constant average rate. In this way, our proposed method can distribute the UEs in a parametric set of the probability distribution. Our proposed mechanism is named as CED RA (CED-RA), which replaces the DUD mechanism in RA with CED to show enhanced reliability and lower latency.

Index Terms—channel access, LTE-A, random access, resource allocation

I. INTRODUCTION

3rd generation partnership project (3GPP) proposes that the higher layer connections among cellular devices (namely known as user equipment [UE]) are given by connecting a UE to an existing cellular network, such as Long-Term Evolution-Advanced (LTE-A) [1]. In an LTE-A network, generally, small amounts of data need to be transmitted from a huge number of UEs. In this way, the UEs perform random access (RA) for transmitting resource requests to the base station, known

TABLE I
LIST OF ABBREVIATIONS AND ACRONYMS USED IN THIS PAPER.

Acronyms	Full description
3GPP	Third Generation Partnership Project
CB	Contention-based
CED	Continuous Exponential Distribution
CF	Contention-free
CRP	Contention Resolution Period
DL	Down-link
DUD	Discrete Uniform Distribution
eNB	Evolved Node B
EPC	Evolved Packet Core
LTE-A	Long Term Evolution-Advanced
MIB	Master Information Block
PDF	Probability Density Function
PDP	Power Delay Profile
PRACH	Physical Random Access Channel
PSS	Primary Synchronization Signal
RA	Random Access
RAN	Radio Access Network
RAR	RA response
RL	Reinforcement Learning
RNTI	Radio Network Temporary Identity
RRC	Radio Resource Connection
SIB	System Information Block
SSS	Secondary Synchronization Signal
TA	Timing Advance
UE	User Equipment
UL	Up-link

as evolved Node B (eNB) [2]. The UEs perform RA utilizing the physical random access channel (PRACH) by a four-step handshake mechanism.

In a dense UE deployment, several UEs try to communicate over the same channel resources, and the UEs contend to access the shared radio resources and create a huge collision problem. Preamble collisions may hamper RA due to simultaneous UE channel access. The challenge of effective RA is crucial due to the rapidly increasing number of connected UEs in the network [3]. A typical LTE-A network consists of two parts: the evolved packet core (EPC) network and the

*Corresponding Author: H. S. Kim (hyungkim@sejong.ac.kr)

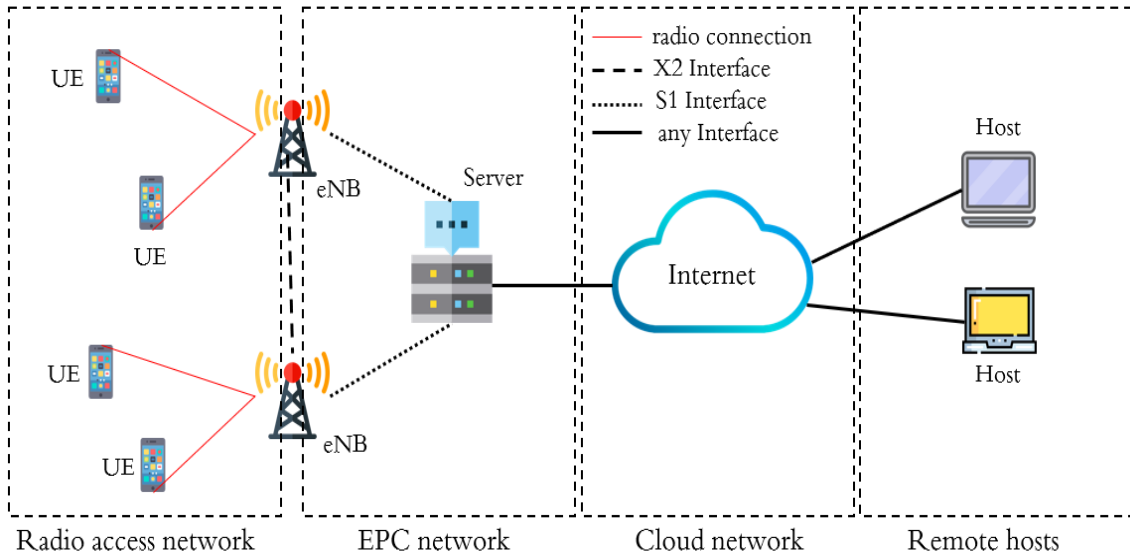

Fig. 1. A typical UE communication in LTE-A networks.

radio access network (RAN) [4]. The EPC is responsible for the overall control of mobile devices and the establishment of an IP packet transmission flow. The RAN is responsible for wireless communication and radio resource access. The RAN, which provides the necessary user and control plane protocols for communicating with mobile devices (UEs) in LTE-A, consists of eNBs. eNBs are interconnected through the X2 interface. Moreover, the eNB is connected to the EPC through the S1 interface. A high-level architecture of LTE-A networks with connected UEs' communication is shown in Fig. 1, where the UEs are connected to the eNBs.

In LTE-A, the minimum resource scheduling unit for downlink (DL) and uplink (UL) transmission is alluded to as a resource block (RB). An RB comprises of 12 subcarriers size of $180kHz$ in the frequency domain (FD) and one subframe size of $1ms$ in the time domain (TD). This time-frequency resource that is RB on which RA is performed is known as PRACH. RA enables UEs to conduct an association initialization, known as contention-based RA procedure [5]. RA preambles are utilized by UEs to start the RA transmission attempt. There is a total of 64 preambles, which are grouped into two categories; contention-free (CF) RA preambles and contention-based (CB) RA preambles. The eNB uses a few preambles for CF RA and designates distinct preambles to various UEs. Residual preambles are utilized for CB RA, where every UE randomly generates one preamble from a discrete uniform distribution (DUD) [4].

DUD is used to avoid the potential collisions in the LTE-A network while multiple UEs try to access the channel resources. However, in a DUD, every UE has equal chance to choose similar contention preamble near to the expected value of the DUD, that is $\frac{(a+b)}{2}$ (for a lower bound a and upper bound b) which may cause an increase in a collision among the UEs. In this work, we propose a method based on the existing alterna-

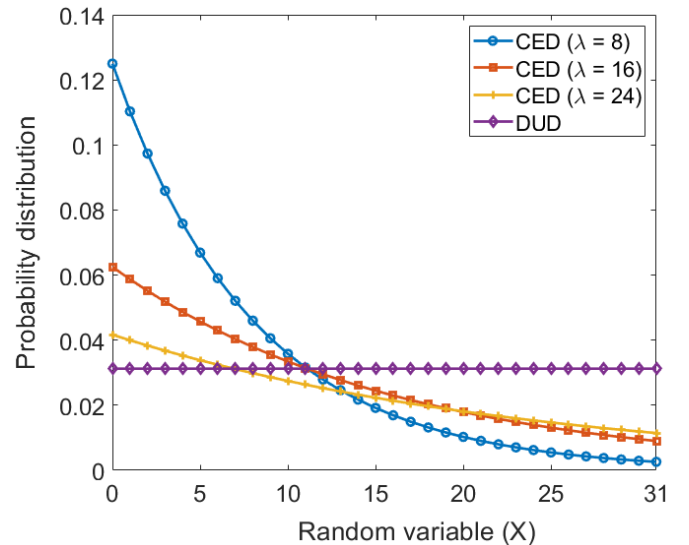

Fig. 2. DUD-based and CED-based (for constant rate parameter $\lambda = \{8, 16, 32\}$) random value dispersion.

tives, such as continuous exponential distribution (CED). CED distributes the random values between two bounds in a poisson point process, in which random variables occur continuously and independently with a constant average rate, which is $\frac{1}{\lambda}$ (for a constant rate parameter λ). The motivation to propose a CED-based RA (CED-RA) mechanism is to distribute the UEs in a parametric set of a probability distribution. Fig. 2 shows the difference of dispersion a random variable (X) between a DUD-based random value and a CED-based random value.

The rest of the paper is organized as follows. In section II, we describe our proposed CED-RA mechanism along with a brief description of the CB RA procedure in LTE-A networks. Simulation results and performance evaluation is discussed in

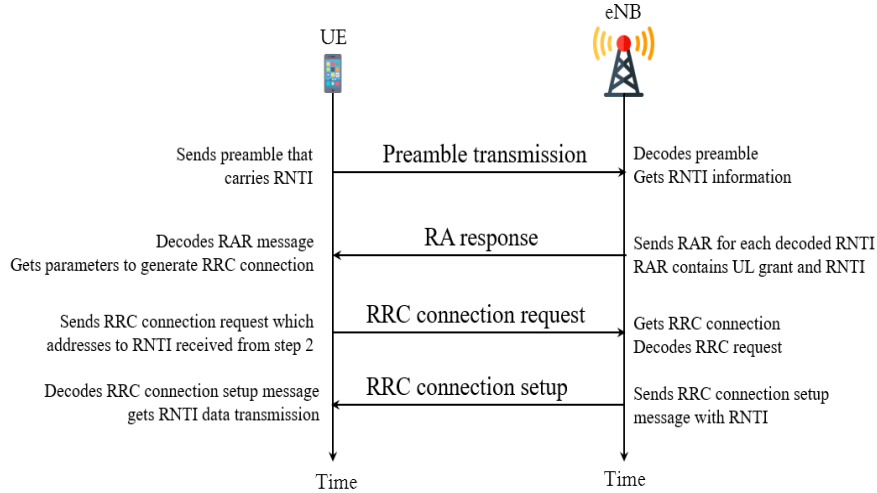

Fig. 3. Contention-based RA procedure in an LTE-A network.

Section III. Finally, in Section IV, a conclusion, along with future work considerations, is presented.

II. EXPONENTIALLY DISTRIBUTED RA PROCEDURE IN LTE-A

At the time when a UE is turned on or awakens, it initially synchronizes with the LTE-A DL channels by interpreting the primary synchronization signal (PSS) and secondary synchronization signal (SSS). The UE at that point separates the master information block (MIB), which contains data about the location of the DL and UL carrier configurations; in this manner, the eNB gets the data of system information block (SIB). This SIB contains all the RA parameters, such as RA slots, RA preambles groups, and preamble configuration. Subsequently, to interpreting the SIB, UEs can produce CB RA transmission attempts.

A. Contention-based RA procedure

There are four major steps performed by the CB RA for association initialization in LTE-A networks. Fig. 3 portrays these four steps with their descriptions.

1) *Preamble transmission (UE → eNB)*: A UE initiates CB RA by selecting a randomly generated one of the accessible CB preambles from a DUD and sends that to the eNB at the next available RACH slot. The eNB periodically broadcasts SIB messages that allow the UEs to choose an appropriate preamble from them. The physical properties of RA preamble in PRACH contain the RA radio network temporary identity (RNTI) and the configuration of the preamble data. The UE waits for an RA response (RAR) window once the preamble is sent.

2) *RA response (eNB → UE)*: The eNB calculates the power delay profile (PDP) of the received preamble on PRACH. This estimated PDP is checked for a predefined threshold, and if it is found higher than the threshold, it is

regarded as an active RA preamble. For every active RA preamble, the eNB decodes the RNTI to discover the RA slot in which the preamble has been sent. Later, the eNB sends a RAR message to the decoded UEs on the DL control message channel. The RAR message contains a timing advance (TA) directive to synchronize ensuing UL transmissions, a UL resource award for radio resource connection (RRC) requirements, and a brief RNTI, which might be made stable at contention resolution period (CRP). However, if various UEs transmit a similar preamble at a similar RA slot, a collision occurs.

3) *RRC connection request (UE → eNB)*: As mentioned in the previous step, channel resources are assigned to the UE; thus, a UE sends RRC connection request and a scheduling request to eNB. At step 3, a message is addressed to the temporary RNTI assigned in RAR message at Step 2 and conveys either a specific RNTI if the eNB already has one RRC-associated UE, or an initial UE identity or a randomly selected number. However, due to a collision in step 2, colliding UEs try to retransmit RA connection requests using the same UL resources; subsequently, more collisions happen in the network.

4) *RRC connection setup (eNB → UE)*: This step is also known as CRP, in which the eNB acknowledges the UE after decoding the RRC request. RRC connection setup messages are sent utilizing the dedicated RNTI. After this, an acknowledgment is sent by the successful UEs to the eNB and carry on for data transmission. However, the collided UEs must wait to initiate a new CB RA procedure if a maximum number of retransmission attempts is reached.

B. Proposed CED random access in LTE-A

In each RA slot, a limited number of preambles are utilized for CB RA. The use of DUD RA for preamble selection has a limitation of arranging contending UEs near an expected value

TABLE II
SIMULATION PARAMETERS AND THEIR VALUES.

Parameter	value(s)
Simulation time	100s
Simulation model	LTE-EPC model
Number of eNBs	2
Number of UEs	2, 4, 8, 16, 32, 64
Distance between UE and eNB	60m
Data payload (packet) sizes	32, 64, 128, 256, 512, 1024Bytes
Packet Interarrival rates	5, 10, 20, 40, 80, 160, 1000ms
Total number of RA preambles	64
CB RA preambles	52

of $\frac{a+b}{2}$, which results in massive collisions after a long run or with several UEs accessing simultaneously. Therefore, we propose to use CED-RA instead of DUD-RA. Our proposed CED-RA arranges most of the contending UEs near the initial preambles. Whereas, the rest of the UEs are placed away from the initial preambles with a contact rate parameter (λ). The CED-RA arrangement allows UEs to access resources as early as possible; meanwhile, each UE also has a small probability of occurring away from most of the UEs, also shown in Fig. 2. The probability density function (PDF) of a CED-RA is determined as

$$f(x; \lambda) = \begin{cases} \lambda e^{-\lambda x}, \forall x \geq 0 \\ 0, \forall x < 0 \end{cases} . \quad (1)$$

As described earlier, here $\lambda > 0$ is the constant rate parameter of the CED.

III. SIMULATION RESULTS AND PERFORMANCE EVALUATION

The proposed CED-RA method reduces the collision rate and increases the UE association's success rate of existing RA without changing the 3GPP LTE RA procedure. We performed simulations in a discrete-event network simulator release 3.30.1 (ns-3.30.1) [6] to verify the performance of the proposed CED-RA method. The performance of the proposed method is evaluated in terms of network reliability and end to end latency. These two parameters are tested for three different scenarios. First we, performed simulations with increasing number of UEs in the LTE-A network ($N_{ue} = \{2, 4, 8, 16, 32, 64\}$). Later, the performance is also evaluated with different data packets sizes and packet interarrival rates. The purpose of performing simulations with different packet sizes and interarrival rates is to evaluate the effects of the proposed method on the actual data transmissions as well. Detailed simulation parameters and there used values are summarized in Table II.

Fig. 4 shows the performance comparison of DUD-RA method with our proposed CED-RA method, where we vary the number of contending UEs in an LTE-A network (network topology is followed as shown in Fig. 1). In Fig. 4(a), we show that the CED-RA method maintains higher reliability as compared to DUD-RA, even in dense UEs deployments, which is 64 UEs. Similarly, the end-to-end latency of the network is also improved when the proposed RA mechanism is used,

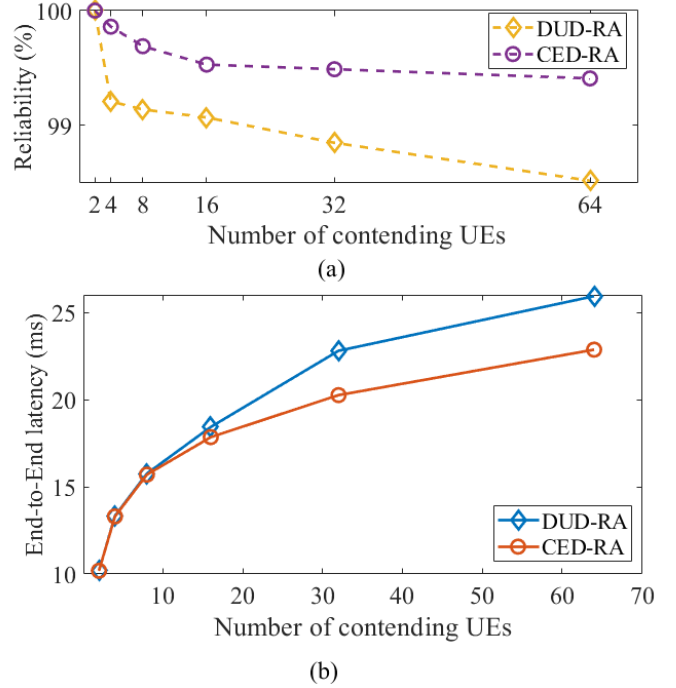

Fig. 4. Performance comparison of DUD-RA and CED-RA with varying number of contending UEs, where (a) network reliability (%), and (b) end-to-end latency (ms).

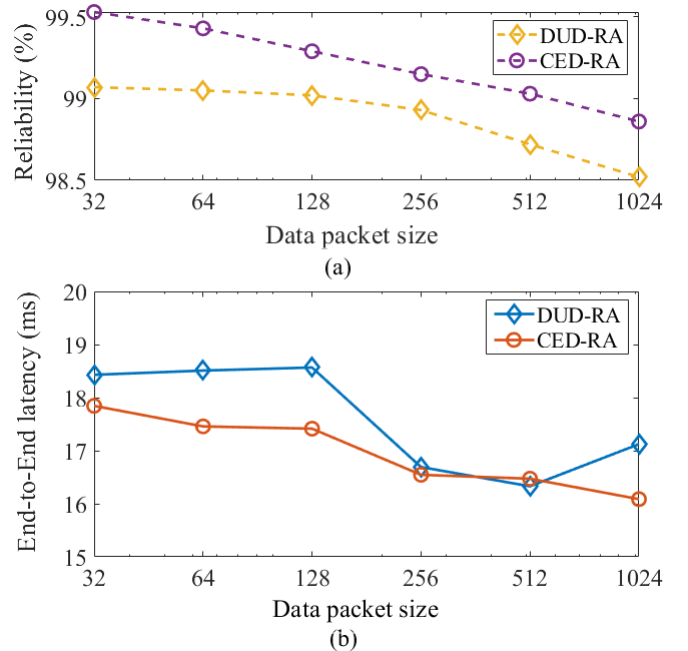

Fig. 5. Performance comparison of DUD-RA and CED-RA with varying data packet sizes, where (a) network reliability (%), and (b) end-to-end latency (ms).

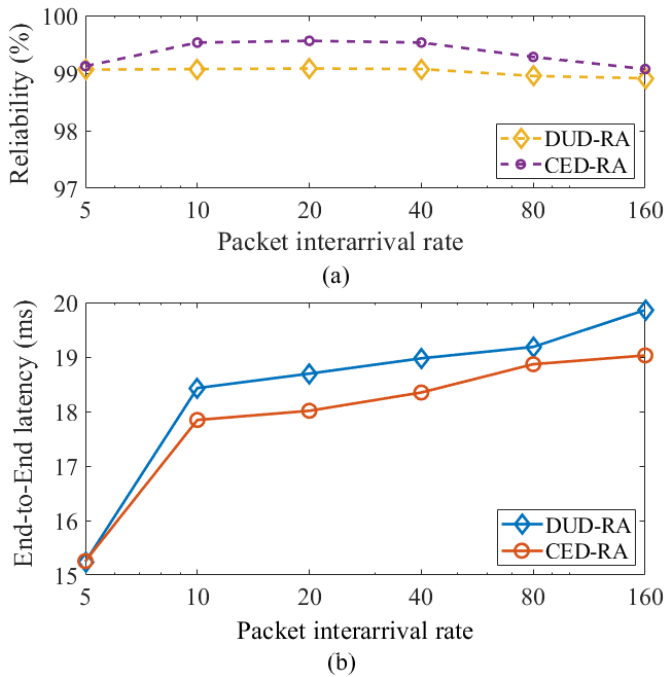

Fig. 6. Performance comparison of DUD-RA and CED-RA with varying packet interarrival rate, where (a) network reliability (%), and (b) end-to-end latency (ms).

as shown in Fig. 4(b). In CED-RA, improved reliability and reduced latency are evident that for a denser UE environment, choosing earlier RA preambles with a constant parametric rate decreases collision among the UEs. The performance of the proposed DUD-RA method is also evaluated with varying data packet sizes. The motivation to evaluate an RA mechanism with different data packet sizes is that the channel resources occupancy time of the UEs very much depends upon the data packet size to transmit. Fig. 5(a) and Fig. 5(b) depicts the impact of different data packet sizes on the reliability and latency of the network. The figures show that the proposed CED-RA method performs better as compared to DUD-RA for both; reliability as well as end-to-end latency. However, the effect of data packet interarrival time has fewer effects on the reliability and latency performance of the network, as shown in Fig. 6(a) and Fig. 6(b), respectively.

From the figures (that is Fig 4-6), we recognize the significance of the use of a continuous exponential distribution. The key objective of the proposed CED for the RA procedure is to let UEs in the network perform their association initialization more efficiently, where the efficiency is attained by reducing collisions in the network.

IV. CONCLUSION AND FUTURE WORK

In cellular communication networks, such as LTE-A, one of the challenges is to provide efficient channel access, especially for denser UE scenarios. In LTE-A, RA is the core channel access mechanism to set up the wireless communication association between a UE and eNB. However, the performance

of the currently implemented RA method considerably affects the increase in contending UEs in the network. One of the reasons for this performance degradation is the use of (DUD) RA procedure in LTE-A networks. In a DUD, every UE has an equal chance to choose similar contention preambles near to the expected value of the DUD, which causes the increase in collisions among the UEs. In this paper, we propose a CED-RA method based on continuous exponential distribution (CED). CED distributes the random values between two bounds in a poison point process, in which random variables occur continuously and independently with a constant average rate. In this way, the CED-RA method distributes the UEs in a parametric set of the probability distribution. The performance evaluation results of simulation experiments show that CED-RA significantly improves the reliability of the network with a reduction in latency as well.

In future considerations, we aim to implement a reinforcement learning-enabled mechanism to optimize the performance of CED-RA. The motivation to implement reinforcement learning for the optimization of the RA procedure in LTE-A is the behaviorist evaluation characteristic of reinforcement learning models.

ACKNOWLEDGMENT

This research was also supported in part by the National Research Foundation of Korea (NRF) grant funded by the Korea government (MSIT) (No.2019R1A4A1023746, No. 2019R1F1A1060799). This work was also supported by the Brain Korea 21 Plus Program (No. 22A20130012814) funded by the National Research Foundation of Korea (NRF).

REFERENCES

- [1] "Study on scenarios and requirements for next-generation access technologies (release 14), V14.2.0," 3GPP, Sophia Antipolis, France, Rep. TR 38.913, Mar. 2017.
- [2] R. Bajracharya, R. Shrestha, R. Ali, A. Musaddiq, and S. W. Kim, "LWA in 5G: State-of-the-art architecture, opportunities, and research challenges," *IEEE Communications Magazine*, vol. 56(10), pp. 134-141, October 2018.
- [3] V. B. Mišić and J. Mišić. *Machine-to-Machine Communications: Architectures, Technology, Standards, and Applications*. CRC Press, Boca Raton, FL, 2014.
- [4] 3GPP TS 36.300 V11.2.0, "Evolved Universal Terrestrial Radio Access (E-UTRA) and Evolved Universal Terrestrial Radio Access Network (EUTRAN), Overall Description," June 2012.
- [5] M. S. Ali, E. Hossain, and D. I. Kim, "LTE/LTE-A Random Access for Massive Machine-Type Communications in Smart Cities," in *IEEE Communications Magazine*, vol. 55, no. 1, pp. 76-83, January 2017. DOI: 10.1109/MCOM.2017.1600215CM
- [6] Ns-3, "A Discrete-Event Network Simulator Release 3.30.1" Online available at: https://www.nsnam.org/doxygen/group_lte.html [Accessed date:10-08-2019]



HOME Welcome Committee

ISNCC 2020 Keynote Speakers **Program** Authors Sponsors

Home → Program

ISNCC 2020 Conference Program at Glance

	Date	Event
Day 1 – Tuesday October 20, 2020	9:00 – 9:30	<p>Welcome & Opening Ceremon</p> <p>Malika Habel (General Director of College Maisonneuve)</p> <p>Prof. Frederic Bouchard (Dean of University of Montreal)</p> <p>Prof. Hussein Mouftah & Prof. Jihene Rezgui (General Chairs)</p> <p>Prof. Tarek Bejaoui (Program Chair)</p>

	9:30 – 10:30	Keynote Speaker 1: Prof. Yoshua Bengio	
	10:30 – 10:45	Coffee Break	
	10:45 – 11:45	Keynote Speaker 2: Prof. Magdy Bayoumi	
	11:45 – 13:15	Lunch Break / Demos 	
	13:15 – 14:15	Keynote Speaker 3: Dr. Belkacem Mouhouche	
	14:15 – 14:30	Coffee Break	
	14:30 – 16:00	A1– Performance Analysis of IoT Networks	A2– Cybersecurity
		A3– Apps of AI/ML in computing and Networking I	A4– Antenna Systems, Propagation and RF Design
		A5– Network Function Virtualization	A6– MLNGSN Workshop
Day 2 – Wednesday October 21, 2020	8:15 – 9:45	B1– Apps of AI/ML in computing and Networking II	B2– Advances in Communications and Energy Harvesting
		B3– Edge, Cloud and Social Computing and Networking I	B4– Trust, Privacy and Security I
		B5– Advances in Engineering for Smart Cities & Applications I	B6– Antenna Systems and Applications
		B7– Advances and QoS Provisioning in Cellular Networks	B8– Quality of Service Provisioning for Mobile Networks
		B9 Satellite communications and Networking I	
	9:45 – 10:00	Coffee Break	
	10:00 – 11:00	Keynote Speaker 4: Prof. Omer Rana	
	11:00 – 11:15	Coffee Break	
	11:15 – 12:15	Keynote Speaker 5: Prof. Soumaya Cherkaoui	
	12:15 – 13:15	Lunch Break & Best Paper Awards Ceremony	
	13:15 – 14:15	Keynote Speaker 6: Dr. Lobao Xavier	
	14:15 – 14:30	Coffee Break	
	14:30 – 16:00	B10– Security and Privacy for IoT	B11– Software Defined Networking

		B12– Quality of Service in Networking	B13– Trust, Privacy and Security II
		B14– SPANM Workshop	
Day 3 – Thursday October 22, 2020	8:15 – 9:45	C1– Systems and Web Applications Security	C2– Satellite communications and Networking II
		C3– Signals and Communication Systems	C4– Applications of AI/ML in Smart Cities
		C5– ML For Safety, Trust and Security	C6– Edge, Cloud and Social Computing and Networking II
		C7– Blockchain and Finance Technology	C8– Advances in Communications and Networking
	9:45 – 10:00	Coffee Break	
	10:00 – 11:00	Keynote Speaker 7: Prof. Hossam Hassanein	
	11:00 – 11:15	Coffee Break	
	11:15 – 12:15	Keynote Speaker 8: Prof. Martin Maier	
	12:15 – 13:15	Lunch Break / Demos 	
	13:15 – 14:15	Keynote Speaker 9: Prof. Latif Ladid	
	14:15 – 14:30	Coffee Break	
	14:30 – 16:00	C9– Networks Security	C10– QoS Provisioning for M2M and Wireless Communications
		C11– Smart Communications and Signals	C12– Advances in Engineering for Smart Cities & Applications II
		C13– Anomaly Detection and Security	
16:00	Closing Ceremony		

Full ISNCC 2020 Conference Program

Tuesday – October 20th, 2020

Opening Ceremony and Keynotes Zoom Link :
<https://cmaisonneuve.zoom.us/my/isncc2020>

9:00 – 9:30

Opening Ceremony

9:30 – 10:30

Keynote 1

“Deep Learning of High-Level Representations”

Dr. Yoshua Bengio (University of Montreal, Canada)

Session Chair: *Dr. Rim Moussa (University of Carthage, Tunisia)*

10:45 – 11:45

Keynote 2

“Intelligent Systems & IoT: A Marriage Made in Heaven”

Dr. Magdy Bayoumi (University of Louisiana at Lafayette, USA)

Session Chair: *Dr. Khalid Elgazzar (Ontario Tech University, Canada)*

11:45 – 13:15

TIPOT Demonstration – Zoom Link :

<https://cmaisonneuve.zoom.us/my/isncc2020>

13:15 – 14:15

Keynote 3

“5G Vertical Industries: From Research to Use Cases Implementation”

Dr. Belkacem Mouhouche (Samsung Electronics, United Kingdom)

Session Chair: *Dr. Suat Özdemir (Hacettepe University, Turkey)*

Technical Sessions

14:30 – 16:00

A1- Performance Analysis of IoT Networks

Zoom Link : <https://cmaisonneuve.zoom.us/j/94893474008>

Session Chair: *Dr. Esko Dijk (Signify Research, The Netherlands)*

1570630974– [Reconfiguration of LoRa Networks Parameters using Fuzzy C-Means Clustering](#),

Aghiles Djoudi (ESIEE School Paris, France); Rafik Zitouni (ECE Paris, France); Nawel Zangar (ESIEE PARIS, France); Laurent George (ESIEE Paris, France)

See Presentation

1570628687– [When Directory Design Meets Data Explosion: Rethinking Query Performance for IoT](#),

Luoyao Hao and Henning Schulzrinne (Columbia University, USA)

[See Presentation](#)

1570630240– [Time Synchronization in IoT Mesh Networks](#),

Tibor Beke (Eindhoven University of Technology, The Netherlands); Esko Dijk (Signify Research, The Netherlands); Tanir Ozcelebi and Richard Verhoeven (Eindhoven University of Technology, The Netherlands)

[See Presentation](#)

1570629029– [NB-IoT Testbed for Industrial Internet of Things](#),

Stephen O Ugwuanyi, James Irvine and Jidapa Hansawangkit (University of Strathclyde, United Kingdom (Great Britain))

[See Presentation](#)

1570631193– [Towards IoT Slicing for Centralized WLANs in Enterprise Networks](#),

Foroutan Fami (Ecole de Technologie Supérieure, Canada); Chuan Pham (Synchromedia Laboratory, Ecole de Technologie Supérieure, Université du Québec, Canada); Kim Khoa Nguyen (University of Quebec, Canada)

[See Presentation](#)

1570632367– [Internet-of-Things \(IoT\) Shortest Path Algorithms and Communication Case Studies for Maintaining Connectivity in Harsh Environments](#)

Ghassan Fadlallah, Hamid Mcheick and Djamel Rebaine (University of Quebec at Chicoutimi, Canada)

[See Presentation](#)

A2- Cybersecurity

Zoom link : <https://cmaisonneuve.zoom.us/j/94893474008>

Session Chair: *Dr. Mingwei Gong (Mount Royal University, Canada)*

1570619406– [Piracy on the Internet: Publisher-side Analysis on File Hosting Services](#),

Marcus Chan (University of Auckland, New Zealand); Mingwei Gong (Mount Royal University, Canada); Ranesh Kumar Naha (University of Tasmania, Australia); Aniket Mahanti (University of Auckland, New Zealand)

[See Presentation](#)

1570618546– [The evolution from Traditional to Intelligent Web Security: Systematic Literature Review,](#)

Carlos José Martínez Santander (Escuela Politécnica Nacional & Universidad Católica de Cuenca, Ecuador); Hugo Moreno (Escuela Superior Politécnica de Chimborazo, Ecuador); Myriam Beatriz Hernández Álvarez (Escuela Politécnica Nacional, Ecuador)

[See Presentation](#)

1570619340– [AI and machine learning: A mixed blessing for cybersecurity,](#)

Faouzi Kamoun (ESPRIT, Tunisia); Farkhund Iqbal (Zayed University, United Arab Emirates); Mohamed Esseghir (ESPRIT, Tunisia); Thar Baker (Liverpool John Moores University, United Kingdom (Great Britain))

[See Presentation](#)

1570631168– [An Optimization Approach to Graph Partitioning for Detecting Persistent Attacks in Enterprise Networks,](#)

Hazem M. Soliman (Rank Software Inc., Canada)

[See Presentation](#)

1570643507– [Smartwatch Dynamics: A Novel Modality and Solution to Attacks on Cyber-behavioral Biometrics for Continuous Verification?,](#)

Khandaker Rahman (Saginaw Valley State University, Michigan, USA); Noor Alam, Jarin Musarrat and Anusha Madarapu (Saginaw Valley State University, USA); Md Hossain (Southern Connecticut State University, USA)

[See Presentation](#)

1570618532– [Dashboard Visualization Techniques in Information Security,](#)

P. Yermalovich (Université Laval & Revenu Québec, Canada)

[See Presentation](#)

A3- Applications of AI/ML in computing and Networking I

Zoom Link : <https://cmaisonneuve.zoom.us/j/99502731438>

Session Chair: *Dr. Serguei A. Mokhov (Concordia University, Canada)*

1570631318– [Multiple UAV based Spatio-Temporal Task Assignment using Fast Elitist Multi Objective Evolutionary Approaches,](#)

Kabo Pule, Mohammad Hossein Anisi, Faiyaz Doctor and Hani Hagraas (University of Essex, United Kingdom (Great Britain))

[See Presentation](#)

1570623024– [A platform for Sharing Artificial Intelligence Algorithms in Autonomous Driving An overview of Enhanced LAOP,](#)

Jihene Rezgui, Clément Bisailon and Léonard Oest O’Leary (College Maisonneuve, Canada)

[See Presentation](#)

1570622999– [OpenISS as a Near-Realtime Composable Broadcast Service for Performing Arts and Beyond,](#)

Serguei A. Mokhov, Jashanjot Singh, Haotao Lai, Konstantinos Psimoulis and Joey Paquet (Concordia University, Canada)

[See Presentation](#)

1570653633– [Mathematical Modeling and Prediction of Neural Network Training based on RC Circuits,](#)

Bhaskar Ghosh (University of Louisiana at Lafayette, USA)

[See Presentation](#)

1570631255– [Bivariate Beta Regression Models and Its Medical Applications,](#)

Pantea Koochemeshkian, Narges Manouchehri and Nizar Bouguila (Concordia University, Canada)

[See Presentation](#)

A4- Antenna Systems, Propagation and RF Design

Zoom Link : <https://cmaisonneuve.zoom.us/j/99385436189>

Session Chair: *Dr. Mohsen Khalily (University of Surrey, UK)*

1570644329– Triple Cassegrain Parabolic Stacked Antenna for Radio Frequency System Consolidation,

Clive Sugama and V. Chandrasekar (Colorado State University, USA)

[See Presentation](#)

1570619372– The SCREAM Concept for the Next-Generation Very Large Array Central Signal Processor,

Omar Yeste Ojeda, Stephen Wunduke, Nolan Denman and Jacob Wegman (National Radio Astronomy Observatory, USA)

[See Presentation](#)

1570631178– Reconfigurable Dielectric Resonator Antenna Using an Inverted U-shaped Slot,

Mohammad Abediankasgari (University of Surrey, United Kingdom (Great Britain)); Mohsen Khalily (University of Surrey & 5G Innovation Centre, Institute for Communication Systems (ICS), United Kingdom (Great Britain)); Shadi Danesh (Babol Noshirvani University of Technology, Iran); Pei Xiao and Rahim Tafazolli (University of Surrey, United Kingdom (Great Britain))

[See Presentation](#)

1570631221– Diffuse Scattering and Specular Reflection from Facets of Arbitrary Size and Roughness using the Computer Graphics GGX Model,

Jean-Frederic Wagen (University of Applied Sciences of Western Switzerland, Fribourg, Switzerland)

[See Presentation](#)

A5- Network Function Virtualization

Zoom Link : <https://cmaisonneuve.zoom.us/j/96621155543>

Session Chair: *Dr. Mehmet Demirci (Gazi University, Turkey)*

1570619260– Analytics Automation for Service Orchestration,

Kristen Young and Ravi Potluri (Verizon, USA)

[See Presentation](#)

1570631232– [Towards the Development of Service Cost Modeling: An ISP Perspective,](#)

Yasmeen Ali (University of Western Ontario, Canada); Anwar Haque (Western Ontario, Canada); Bassel Bitar (Bell Canada, Canada)

[See Presentation](#)

1570623031– [Failure Scenarios for SIP/RTP services in ContainerOrchestration Clusters,](#)

Samridhi Samridhi (Ontario Tech University, Canada); Ramiro Liscano (University of Ontario Institute of Technology, Canada); Akramul Azim (Ontario Tech University, Canada); Abdul Zainul Abedin (University of Ontario Institute of Technology, Oshawa, ON, Canada)

[See Presentation](#)

1570622444– [A Fair VNF Assignment Algorithm for Network Functions Virtualization,](#)

KaranbirSingh Ghai (Lakehead University, Canada); Abdulsalam Yassine (unknown); Salimur Choudhury (Lakehead University, Canada)

[See Presentation](#)

1570631235– [Cost and Availability-Aware VNF Selection and Placement for Network Services in NFV,](#)

Yanal Alahmad, Anjali Agarwal and Tariq Daradkeh (Concordia University, Canada)

[See Presentation](#)

1570630920– [On the Use of Graph Neural Networks for Virtual Network Embedding,](#)

Anouar Rkhami (Inria, Univ Rennes, CNRS, IRISA, France); Tran Anh Quang Pham (Huawei Technologies, France); Yassine Hadjadj-Aoul (University of Rennes 1, France); Abdelkader Outtagarts (Nokia Bell Labs France, France); Gerardo Rubino (INRIA, France)

[See Presentation](#)

A6 – MLNGSN Workshop

Zoom Link : <https://cmaisonneuve.zoom.us/j/97857109452>

Session Chair: *Dr. Mohamed Lahby (Hassan II University, Morocco)*

1570639432 – [Using Machine Learning to Locate Gateways in the Wireless Backhaul of 5G Ultra-Dense Networks,](#)

Aizaz U Chaudhry, Mital Raithatha, Roshdy H Hafez and John Chinneck (Carleton University, Canada)

[See Presentation](#)

1570639438 – [An IoT Based Smart Farming System Using Machine Learning,](#)

Amine Dahane (Research Laboratory in Industrial Computing and Networks (RIIR), Algeria)

[See Presentation](#)

1570656354 – [Polymorphic Adversarial DDoS attack on IDS using GAN,](#)

Ravi Chauhan and Shahram Shah Heydari (University of Ontario Institute of Technology, Canada)

[See Presentation](#)

Wednesday – October 21st, 2020

Keynotes Zoom Link : <https://cmaisonneuve.zoom.us/my/isncc2020>

10:00 – 11:00

Keynote 4

“Service Orchestration & Enactment Across Cloud & Edge Resources”

Dr. Omer Rana (Cardiff University, United Kingdom)

Session Chair: *Dr. Abdelhakim Hafid (University of Montreal, Canada)*

11:15 – 12:15

Keynote 5

“Enabling Machine Learning at the Edge”

Dr. Soumaya Cherkaoui (University of Sherbrooke, Canada)

Session Chair: *Dr. Leila Ismail (College of IT, UAE University, UAE)*

12:15 – 13:15

Best Paper Award Ceremony – Zoom Link :
<https://cmaisonneuve.zoom.us/my/isncc2020>

13:15 – 14:15

Keynote 6

“TBA”

Dr. Lobao Xavier (European Space Agency, The Netherlands)

Session Chair: *Dr. Michele Luglio (University of Rome Tor Vergata, Italy)*

Technical Sessions

8:15 – 9:45

B1- Applications of AI/ML in computing and Networking II

Zoom Link : <https://cmaisonneuve.zoom.us/j/92701503929>

Session Chair: *Dr. Hamid Mcheick (University of Quebec at Chicoutimi, Canada)*

1570622707 – [Probabilistic Features on Simplex Manifold in Predictive Data Modelling,](#)

Md. Hafizur Rahman and Nizar Bouguila (Concordia University, Canada)

[See Presentation](#)

1570623001 – [Enabling Real-time Gesture Recognition Data Delivery over ROS and OpenISS,](#)

Jashanjot Singh, Serguei A. Mokhov and Joey Paquet (Concordia University, Canada)

[See Presentation](#)

1570650438 – [DeepFlow: Towards Network-Wide Ingress Traffic Prediction Using Machine Learning At Large Scale,](#)

Katerina Katsarou (Technische Universität Berlin, Germany); Sebastian Fischer (Technische Universität Berlin / Germany & Deutsche Telekom AG, Germany); Oliver Holschke (Deutsche Telekom AG, Germany)

[See Presentation](#)

1570631058 – [Review of Techniques in Faceted Search Applications,](#)

Mohammed Najah Mahdi (University Tenaga National & Malaysia, Malaysia); Abdul Rahim Ahmad and Roslan Ismail (Universiti Tenaga Nasional, Malaysia); Mohammed Subhi (Universiti Kebangsaan Malaysia, Malaysia)

[See Presentation](#)

1570619360 – [Recognition of human interactions in feature films based on infinite mixture of EDCM,](#)

Fatma Najar, Nuha Zamzami and Nizar Bouguila (Concordia University, Canada)

[See Presentation](#)

1570640118– [Building a Fintech Ecosystem: Design and Development of a Fintech API Gateway,](#)

Ersin Unsal, Bilgehan Oztekin and Murat Cavus (Fibabanka A.Ş., Turkey); Suat Ozdemir (Gazi University, Turkey)

[See Presentation](#)

B2- Advances in Communications and Energy Harvesting

Zoom Link : <https://cmaisonneuve.zoom.us/j/94303952294>

Session Chair: *Dr. Alain Richard Ndjiongue (University of Johannesburg, South Africa)*

1570619301– [Energy-Efficient Power Allocation for Non-Orthogonal Multicast and Unicast Transmission of Cell-Free Massive MIMO Systems,](#)

Fangqing Tan, Peiran Wu and Minghua Xia (Sun Yat-sen University, China)

[See Presentation](#)

1570653440– [Fault Tolerance of Multi-Channel Radio Network with Dynamic Spectrum Access Strategy in Air Traffic Management Systems,](#)

Igor Kabashkin (Transport and Telecommunication Institute, Latvia)

[See Presentation](#)

1570609418– [LED-based Energy Harvesting Systems for Modern Mobile Terminals,](#)

Alain Richard Ndjiongue (University of Johannesburg, South Africa); Telex M. N. Ngatched (Memorial University of Newfoundland, Canada)

[See Presentation](#)

1570646196– [Performance Analysis of Cooperative Bidirectional Relay in Cognitive Radio Network with Energy Harvesting,](#)

Ke Yan and Xie Xian-Zhong (Chongqing University of Posts and Telecommunications, China)

[See Presentation](#)

1570619426– [Performance of Mixed Channel Cell-Free Systems](#),

Rafael M. Duarte (Universidade Federal de Campina Grande, Brazil); Danilo Almeida (UFCG, Brazil); Marcelo S. Alencar (Federal University of Campina Grande & Institute for Advanced Studies in Communications, Brazil); Fabricio Braga Soares de Carvalho (Federal University of Paraiba – UFPB, Brazil); Wamberto Queiroz (Universidade Federal de Campina Grande, Brazil); Waslon Lopes (Universidade Federal da Paraíba & IECOM – Institute for Advanced Studies in Communications, Brazil)

[See Presentation](#)

B3- Edge, Cloud and Social Computing and Networking I

Zoom Link : <https://cmaisonneuve.zoom.us/j/96056687655>

Session Chair: *Dr. Adel Benmnaouer (Canadian University Dubai; UAE)*

1570619365– [Caching Structures for Distributed Data Management in P2P-based Social Networks](#),

Newton W. Masinde and Moritz Kanzler (Heinrich Heine Universität, Düsseldorf, Germany); Kalman Graffi (Heinrich Heine University Düsseldorf, Germany)

[See Presentation](#)

1570644610– [Automating GDPR Compliance Verification for Cloud-hosted Services](#),

Masoud Barati, George Theodorakopoulos and Omer Rana (Cardiff University, United Kingdom (Great Britain))

[See Presentation](#)

1570653397– [A Non-Cooperative transportation game to optimize resource allocation in edge-cloud environment](#),

Njakarison Menja Randriamasinoro (Ecole de Technologie Superieure, Canada & Ecole Supérieure Polytechnique d’Antsiranana, Madagascar); Kim Khoa Nguyen (University of Quebec, Canada); Mohamed Cheriet (Ecole de technologie superieure (University of Quebec), Canada)

[See Presentation](#)

1570653743– [A Framework for Automated Monitoring and Orchestration of Cloud-Native applications,](#)

Rasel Chowdhury and Chamseddine Talhi (École de Technologie Supérieure, Canada); Azzam Mourad (Lebanese American University, Lebanon); Hakima Ould-Slimane (ETS, Canada)

[See Presentation](#)

1570629996– [Opening the Network Edge for Programmability of Mission Critical Session Control,](#)

Ivaylo Atanasov, Evelina Pencheva, Denitsa Velkova and Vencislav Trifonov (Technical University of Sofia, Bulgaria)

[See Presentation](#)

1570659008– [Transparent Provable Data Possession Scheme for Cloud Storage,](#)

Shinobu Ogiso and Masami Mohri (Gifu University, Japan); Yoshiaki Shiraishi (Kobe University, Japan)

[See Presentation](#)

1570623002– [Toward Scalable Demand-Driven JSON-to-Forensic Lucid Encoder in GIPSY,](#)

Peyman Derafshkavian, Serguei A. Mokhov and Joey Paquet (Concordia University, Canada)

[See Presentation](#)

B4- Trust, Privacy and Security I

Zoom Link : <https://cmaisonneuve.zoom.us/j/97362748376>

Session Chair:*Dr. Abdelkader Ouda (University of Western Ontario, Canada)*

1570619374– [Two Factor Hash Verification \(TFHV\): A Novel Paradigm for Remote Authentication,](#)

Muath Obaidat (City University of New York, USA)

[See Presentation](#)

1570619428– [Privacy-aware Authentication Scheme for Electric Vehicle In-motion Wireless Charging,](#)

Khaled Hamouid (UQO, Canada); Kamel Adi (University of Quebec in Outaouais, Canada)

[See Presentation](#)

1570619443– [Human Trait Analysis via Machine Learning Techniques for User Authentication](#),

Iman Abu Sulayman (Taif University, Saudi Arabia & Western University, Canada); Abdelkader Ouda (University of Western Ontario, Canada)

[See Presentation](#)

1570630517– [Improving Accuracy of Differentially Private Kronecker Social Networks via Graph Clustering](#),

Arinjita Paul (Indian Institute of Technology Madras, India); Vorapong Suppakitpaisarn (The University of Tokyo, Japan); Mitali Bafna (Harvard University, USA); C Pandu Rangan (IIT Madras, India)

[See Presentation](#)

1570619429– [Continuous Authentication Using Creative Writing](#),

Md Hossain and Carl Haberfeld (Southern Connecticut State University, USA); Kate Yuan (Dartmouth College, USA); Jundong Chen (Dickinson State University, USA); Khandaker Rahman (Saginaw Valley State University, Michigan, USA); Ishtiaque Hussain (Penn State Abington, USA)

[See Presentation](#)

1570631320– [Towards A Secure and Efficient Location-based Secret Sharing Protocol](#),

Alexey Gorodetskiy, Andrey Serebryakov and Alma Oracevic (Innopolis University, Russia); Rasheed Hussain (Innopolis University & Networks and Blockchain Lab, Russia); Syed Muhammad Ahsan Raza Kazmi (Innopolis University, Russia)

[See Presentation](#)

B5- Advances in Engineering for Smart Cities & Applications I

Zoom Link : <https://cmaisonneuve.zoom.us/j/95278184564>

Session Chair: *Dr. Amna Eleyan (Manchester Metropolitan University, UK)*

1570622725– [Smart Wireless network for data collection using mobile Sink embedded on drone based on a modified RPL-version,](#)

Sèmèvo Arnaud R. M. Ahouandjinou (Institut de Formation et de Recherche en Informatique (IFRI), Benin) ; Emmanuel Nataf (Lorraine University & Lirima, France) ; Aldric Monnou and Firmin Yelouassi (Université d'Abomey-Calavi, Benin)

[See Presentation](#)

1570623447– [Seizure Prediction with a Single iEEG Electrode Using Non-linear techniques,](#)

Tahar Haddad (UQO, Canada); Naim Ben-Hamida (Ciena, Canada); Sadok Aouini (Ciena Corporation, Canada); Jihene Rezgui (College Maisonneuve, Canada)

[See Presentation](#)

1570641375 –[IoT-based Home Automation Using Android Application](#)

Amna Eleyan (MMU, United Kingdom (Great Britain)); Joshua Fallon (Manchester Metropolitan University, United Kingdom (Great Britain))

See Presentation

1570619400– [A Realistic and Efficient Real-time Plant Environment Simulator,](#)

Jeongwon Seo (University of Auckland, New Zealand); Mingwei Gong (Mount Royal University, Canada); Ranesh Kumar Naha (University of Tasmania, Australia); Aniket Mahanti (University of Auckland, New Zealand)

[See Presentation](#)

1570622701– [Incentive-based Peer-to-Peer Distributed Energy Trading in Smart Grid Systems,](#)

JemaSharin Pankiraj, Yassine Abdulsalam and Salimur Choudhury (Lakehead University, Canada)

[See Presentation](#)

1570652995- [Leveraging Deep Learning for Inattentive Driving Behavior with In-Vehicle Cameras,](#)

Shanhong Liu (University of Guelph & School of Engineering, Canada); Radu Muresan (University of Guelph, Canada); Arafat Al-Dweik (Khalifa University, United Arab Emirates)

[See Presentation](#)

1570622731– [Achieving Immortality in Wireless Rechargeable Sensor Networks Using Local Learning,](#)

Osama Aloqaily and Paola Flocchini (University of Ottawa, Canada); Nicola Santoro (Carleton University, Canada)

[See Presentation](#)

B6- Antenna Systems and Applications

Zoom Link : <https://cmaisonneuve.zoom.us/j/95588152738>

Session Chair: *Dr. Mohsen Khalily (University of Surrey, UK)*

1570617726– [Submarine Antenna Performance with Novel Shaped Sandwich-Wall Radome,](#)

Hafiz Usman Tahseen, Yang Lixia and Saad Uddin (Jiangsu University, China)

[See Presentation](#)

1570631302– [Millimeter Wave Phased Array Antenna Synthesis Using a Machine Learning Technique for Different 5G Applications,](#)

Shadi Danesh (Babol Noshirvani University of Technology, Iran); Ali Araghi (University of Surrey, United Kingdom (Great Britain)); Mohsen Khalily (University of Surrey & 5G Innovation Centre, Institute for Communication Systems (ICS), United Kingdom (Great Britain)); Pei Xiao and Rahim Tafazolli (University of Surrey, United Kingdom (Great Britain))

See Presentation

1570634164– [Analysis of Triple Band Rejected Compact Planar Octagon shape Monopole Antenna for UWB Applications,](#)

Gurdeep Singh (Thapar Insitute of Engineering & Technology & Thapar Insitute of Engineering & Technology Patiala, India)

[See Presentation](#)

1570645980– [Miniturized Spiral UWB Transparent Wearable Flexible Antenna for Breast Cancer Detection,](#)

Tale Saeidi (Universiti Teknologi PETRONAS, Malaysia); Sarmad Mahmood (Lecturer, Al-Kitab University College, Iraq); Asnor Juraiza Ishak (Universiti Putra Malaysia & Faculty of Engineering, Malaysia); Sameer Alani (Universiti Teknikal Malaysia Melaka, Iraq); Idris bin Ismail (Universiti

Teknologi PETRONAS, Malaysia); Shahid Ali (Petronas University Malaysia, Malaysia); Adam Alhawari (Najran University, Saudi Arabia)

[See Presentation](#)

1570621561 – [Six-minute walk test automation for people with cardiorespiratory disease,](#)

Lucas R A Duarte, Gabriel Messias Mamede Costa, Sr Gabriel and Marcielly dos Reis Macedo (Centro Universitário Santo Agostinho, Brazil); Vinicius Magno Uchoa Lima Oliveira (Centro Universitário Santo Agostinho & Hospital Universitário do Piauí – EBSEH, Brazil)

[See Presentation](#)

B7- Advances and QoS Provisioning in Cellular Networks

Zoom Link : <https://cmaisonneuve.zoom.us/j/94247674472>

Session Chair: *Dr. Mohamed Lahby (Hassan II University, Morocco)*

1570646199 – [Congestion Mitigation using Non-Cooperative Game Theory in LTE Base Stations,](#)

Avirop Ghosh (Royal Melbourne Institute of Technology, Australia); Karina Mabell Gomez and Sithamparanathan Kandeepan (RMIT University, Australia)

[See Presentation](#)

1570631241 – [Analysis of Blockage Impact on Handover Rate for User Mobility in 5G mm-Wave Cellular Network,](#)

Abdanaser Okaf and Dongyu Qiu (Concordia University, Canada)

[See Presentation](#)

1570619147 – [Exponentially Distributed Random Access in LTE-A networks,](#)

Rashid Ali (Sejong University, Korea (South)); Nain Zulqar and **Sung Won Kim** (Yeungnam University, Korea (South)); Hyung Seok Kim (Sejong University, Korea (South))

[See Presentation](#)

1570618839– [On Evaluating Independent Set Heuristics for Wireless Backhaul Network Capacity of 5G Ultra-Dense Networks,](#)

Aizaz U Chaudhry, Namitha Jacob, Dils George and Roshdy H Hafez (Carleton University, Canada)

[See Presentation](#)

1570627393– [Proactive and Dynamic Slice Allocation in Sliced 5G Core Networks,](#)

Danish Sattar and Ashraf Matrawy (Carleton University, Canada)

[See Presentation](#)

1570649863– [Joint Impact of BS Height and Downtilt on Downlink Data Rate in mmWave Networks with 3D Large-Scale Antenna Arrays,](#)

Mengxin Zhou (University of Sheffield, United Kingdom (Great Britain)); Wuling Liu (Chinese Academy of Sciences, China); Jiliang Zhang (The University of Sheffield, United Kingdom (Great Britain)); Xiaoli Chu (University of Sheffield, United Kingdom (Great Britain))

[See Presentation](#)

B8- Quality of Service Provisioning for Mobile Networks

Zoom Link : <https://cmaisonneuve.zoom.us/j/94634842857>

Session Chair: *Dr. Waheb Abduljabbar Shaif Abdullah (Universiti Malaysia Pahang (UMP); Malaysia)*

1570619045– [A Different Perspective in Routing for VANETs,](#)

Yuri Cotrado Sehgelmeble (Universität zu Lübeck, Germany)

[See Presentation](#)

1570622786– [Resource efficient allocation of fog nodes for faster vehicular OTA updates,](#)

Md Al Maruf (Ontario Tech University, Canada); Anil Singh (Indian Institute of Technology Ropar, Canada); Akramul Azim (Ontario Tech University, Canada); Nitin Auluck (Indian Institute of Technology Ropar, India)

[See Presentation](#)

1570633516– [Full Duplex of V2V Cooperative Relaying over Cascaded Nakagami- \$m\$ Fading Channels](#),

Khaled Eshteiwi (University of ETS, Canada); Bassant Selim (École de Technologie Supérieure, Canada); Georges Kaddoum (ETS Engineering School, University of Québec, Canada)

[See Presentation](#)

1570631435– [MPLS-Based Micro-mobility Architecture for 5G Vehicular Visible Light Communication Networks](#),

Sameera Siddiqui and Dimitrios Makrakis (University of Ottawa, Canada)

[See Presentation](#)

1570614108– [Comparative Performance Analysis of MBQA-OLSRv2 and MBMA-OLSRv2 Routing Protocols in MANETs](#),

Waheb Abduljabbar Shaif Abdullah (Faculty of Electrical and Electronics Engineering Technology, Universiti Malaysia Pahang (UMP), Malaysia)

[See Presentation](#)

1570622781– [Resource Pre-allocation for Cooperative Sensing to Achieve End-to-end Delay Fairness in CRNs](#),

Yean-Fu Wen (National Taipei University, Taiwan)

[See Presentation](#)

B9- Satellite communications and Networking I

Zoom Link : <https://cmaisonneuve.zoom.us/j/99494256243>

Session Chair: *Dr. Nawel Zangar (ESIEE PARIS, France)*

1570619392– [A New Approach for Analyzing the Cycle Structure of a Class of LFSRs](#),

Zhelin Yu and Lidong Zhu (University of Electronic Science and Technology of China, China)

[See Presentation](#)

1570631390– [Improved OFDM Waveform for Radio Link in Non-terrestrial Network](#),

Yang Li, Xinjie Gu, Lilin Dan, Ranran He, Xing Mao and Yue Xiao (University of Electronic Science and Technology of China, China)

[See Presentation](#)

1570633008– [Terrestrial-Satellite Secure Communication with Non-confidential User Assistance and Hybrid-Power,](#)

Yilun Liu, Yiheng Gui, Shuai Yuan, Jixuan Liu and Lidong Zhu (University of Electronic Science and Technology of China, China)

[See Presentation](#)

1570633788– [Cognitive CQI/5QI Based Scheme for Software Defined 5G Hybrid Satellite-Terrestrial Network: Slicing for Ultra Reliability And Video Congestion Offloading,](#)

Saloua Hendaoui (High School of Communication of Tunis (SUPCOM) & Multimedia Mobile Radio Networks Research Unit-Tunis, Tunisia); Azza Mannai (Faculty of Mathematical, Physical and Natural Sciences of Tunis & University of Tunis El Manar, Tunisia); Nawel Zangar (ESIEE PARIS, France)

[See Presentation](#)

1570646570– [On Application of MUSIC Algorithm to Doppler Estimation for Aeronautical Satellite OFDM,](#)

Houssein Boud (Western University, Canada)

[See Presentation](#)

14:30 – 16:00

B10- Security and Privacy for IoT

Zoom Link : <https://cmaisonneuve.zoom.us/j/95664822325>

Session Chair: *Dr. Abderrahmane Maaradji (Queensland University of Technology, Australia)*

1570630977– [Towards a Decentralized Access Control System for IoT platforms based on Blockchain Technology,](#)

Dana Haj Hussein, Ragnath Anbarasu, Ashraf Matrawy and Mohamed Ibnkahla (Carleton University, Canada)

[See Presentation](#)

1570653676– [Security Analysis of IoT Networks and Platforms](#),

Stephen O Ugwuanyi (University of Strathclyde, United Kingdom (Great Britain))

[See Presentation](#)

1570634098– [A Pragmatic Cybersecurity Strategies for Combating IoT-Cyberattacks](#),

Amir Djenna (University of Constantine, Algeria)

[See Presentation](#)

1570633222– [A New Security Framework for Remote Patient Monitoring Devices](#),

Vahid Heydari (Rowan University, USA)

[See Presentation](#)

1570630231– [Privacy preserving issues in the dynamic internet of things](#),

Aine MacDermott, John Carr and Qi Shi (Liverpool John Moores University, United Kingdom (Great Britain)); Mohd Rizuan (Universiti Teknikal Malaysia, Malaysia); Gyu Myoung Lee (Liverpool John Moores University, United Kingdom (Great Britain))

[See Presentation](#)

1570633037– [Forensic Analysis of the August Smart Device Ecosystem](#),

Shinelle Hutchinson and Umit Karabiyik (Purdue University, USA)

[See Presentation](#)

B11- Software Defined Networking

Zoom Link : <https://cmaisonneuve.zoom.us/j/99331182149>

Session Chair: *Dr. Ramiro Liscano (University of Ontario Institute of Technology, Canada)*

1570621968– [A Framework for QoS-based Routing in SDNs Using Deep Learning](#),

Isaac Owusu and Amiya Nayak (University of Ottawa, Canada)

[See Presentation](#)

1570622539- [Proactive Disturbance-Aware Routing within Software-Defined Networking,](#)

Ahmad Abdo, Khaled Maamoun, Claude D'Amours and Hussein T. Mouftah (University of Ottawa, Canada)

[See Presentation](#)

1570631137- [Searching for Optimal Software Defined Network Controller Against DDoS Attacks,](#)

Georgi Iliev and Branislav Mladenov (Technical University of Sofia, Bulgaria)

[See Presentation](#)

1570631195- [Performance comparison of a Software Defined and Wireless Sensor Network,](#)

Samridhi Samridhi (Ontario Tech University, Canada); Ramiro Liscano (University of Ontario Institute of Technology, Canada)

[See Presentation](#)

1570622366- [Multi-stage Jamming Attacks Detection using Deep Learning Combined with Kernelized Support Vector Machine in 5G Cloud Radio Access Networks,](#)

Marouane Hachimi (Ecole de Technologie upérieure, Canada) ; Georges Kaddoum (ETS Engineering School, University of Québec, Canada) ; Ghyslain Gagnon (ETS, Canada) ; Poulmanogo Illy (École de Technologie Supérieure, Canada)

[See Presentation](#)

B12- Quality of Service in Networking

Zoom Link : <https://cmaisonneuve.zoom.us/j/95539146227>

Session Chair: *Dr. Francesco Zampognaro (University of Rome Tor Vergata, Italy)*

1570662266- [Proportionally Fair approach for Tor's Circuits Scheduling,](#)

Lamiaa Basyoni, Aiman Erbad and Amr Mohamed (Qatar University, Qatar); Ahmed Refaey (Manhattan College, USA & Western University, Canada); Mohsen Guizani (Qatar University, Qatar)

[See Presentation](#)

1570654428- [Virtual Cut-Through Routing in Multidimensional Interconnection Networks,](#)

Lev B Levitin (Boston University, USA); Yelena Rykalova (UMass Lowell, USA)

[See Presentation](#)

1570653308- [Green Crowdsensing by Learning Inter-Auction Mappings and Non-local Graph Constraints,](#)

Maggie E. Gendy (Arab Academy for Science, Technology and Maritime Transport, Egypt); Ahmad Al-Kabbany (Arab Academy for Science and Technology, Egypt); Ehab F. Badran (Arab Academy for Science, Technology and Maritime Transport, Egypt)

[See Presentation](#)

1570652821- [Joint Placement Latency Optimization of the Control Plane,](#)

Kurdman Abdulrahman Rasol (Universitat Politècnica de Catalunya, Spain); Jordi Domingo-Pascual (Universitat Politècnica de Catalunya – BarcelonaTech (UPC) & Technical University of Catalunya (UPC) Advanced Broadband Communications Center, Spain)

[See Presentation](#)

1570619424- [External Synchronisation in Time-Triggered Networks,](#)

Nahman Tariq, Ivan Petrunin and Saba Al-Rubaye (Cranfield University, United Kingdom (Great Britain))

[See Presentation](#)

1570639476- [Peers Classification and Monitoring in a P2P System,](#)

Fatima Lamia Haddi (University Of Sciences and Technology Houari Boumediene, Algeria); Benchaïba Mahfoud (Université des Sciences & Technologie Houari Boumediene (USTHB), Algeria); Jihene Rezgui (College Maisonneuve, Canada), Tarek Bejaoui (University of Carthage, Tunisia)

[See Presentation](#)

B13- Trust, Privacy and Security II

Zoom Link : <https://cmaisonneuve.zoom.us/j/92433989150>

Session Chair: *Dr. Abdelkader Ouda (University of Western Ontario, Canada)*

1570619371 – [Privacy Preserving Path Planning in an Adversarial Zone,](#)

Iman Vakilinia (University of North Florida, USA); Mohammad Jafari (University of California Santa Cruz, USA); Deepak K Tosh (University of Texas, El Paso, USA); Shahin Vakilinia (Synchromedia, Canada)

[See Presentation](#)

1570622733 – [Decentralized and Privacy-Preserving Key Management Model,](#)

Reza Soltani, Uyen Trang Nguyen and Aijun An (York University, Canada)

[See Presentation](#)

1570646216 – [Utility Analysis of Horizontally Merged Multi-Party Synthetic Data with Differential Privacy,](#)

Bingyue Su (University of Notre Dame, USA); Fang Liu (USA & University of Notre Dame, USA)

[See Presentation](#)

1570631190 – [PMBFE: Efficient and Privacy-Preserving Monitoring and Billing Using Functional Encryption for AMI Networks,](#)

Mohamed I Ibrahim and Mahmoud Badr (Tennessee Technological University, USA); Mostafa M. Fouda (Tennessee Tech University, USA & Benha University, Egypt); Mohamed M E A Mahmoud (Tennessee Tech University, USA); Waleed Alasmay (Umm Al-Qura University, Saudi Arabia); Zubair Md. Fadlullah (Computer Science, Lakehead University, Canada)

[See Presentation](#)

1570636818 – [Vulnerabilities Assessment for Unmanned Aerial Vehicles Communication Systems,](#)

Lamia Chaari (University of Computer Science and Multimedia of Sfax & Laboratory of Technologies for Smart Systems at Digital Research Center of Sfax (CRNS), Tunisia); Sana Chahbani (Digital Research Center of Sfax (CRNS), Tunisia); Jihene Rezgui (College Maisonneuve, Canada)

[See Presentation](#)

1570619444 – [Designing Security User Profiles via Anomaly Detection for User Authentication,](#)

Iman Abu Sulayman (Taif University, Saudi Arabia & Western University, Canada); Abdelkader Ouda (University of Western Ontario, Canada)

[See Presentation](#)

B14- SPANM Workshop

Zoom Link : <https://cmaisonneuve.zoom.us/j/98459629174>

Session Chair: *Dr. Amjed Gawanmeh (Khalifa University of Science and Technology, UAE)*

1570630821 – [Comparing OLSRd, d2 and -Q Using an Emulated 802.11 or TDMA MANET in a 2-ring Topology,](#)

Jean-Frederic Wagen (University of Applied Sciences of Western Switzerland, Fribourg, Switzerland); Victor Adalid (Switzerland); Yann Maret (University of Applied Sciences of Western Switzerland, Fribourg, Switzerland)

[See Presentation](#)

1570635622 – [Narrow-band Internet of Things Protocol Standards: Survey of Security and Privacy Control Effectiveness,](#)

Eric W Yocam (University of Washington, USA)

[See Presentation](#)

1570658441 – [Routing Solutions for Hierarchical MANETs,](#)

Thomas Kunz (Carleton University, Canada)

[See Presentation](#)

1570661338 – [Recent Advances on 5G Resource Allocation Problem using PD-NOMA,](#)

Sally Ismail (Université de Technologie de Compiègne & Université Libanaise, France) ; Fabio D'Andreagiovanni (CNRS, Sorbonne University – UTC, France) ; Hicham Lakhlef (Heudiasyc, University of Technology of Compiègne, France) ; Imine Youcef (University de Technologie de Compiègne, France)

[See Presentation](#)

1570660129 – [Performance Evaluation and Analysis of Geometric Area Analysis Technique for Anomaly Detection Using Trapezoidal Area Estimation Based on Mixture Models,](#)

Yogesh P Pawar, Manar Amayri and Nizar Bouguila (Concordia University, Canada)

[See Presentation](#)

1570639585 – [A Thermal Aware Approach to Enhance 5G Device Performance and Reliability in mmWave Networks](#),

Anurag Thantharate (University of Missouri Kansas City, USA)

[See Presentation](#)

Thursday – October 22nd, 2020

Keynotes Zoom Link : <https://cmaisonneuve.zoom.us/my/isncc2020>

10:00 – 11:00

Keynote 7

“Collaborative Caching in Next Generation Wireless Networks”

Dr. Hossam Hassanein (Queens’s University, Canada)

Session Chair: *Dr. Lidong Zhu (University of Electronic Science and Technology of China, China)*

11:15 – 12:15

Keynote 8

“The Internet of No Things: From “Connected Things” to “Connected Human Intelligence”

Dr. Martin Maier (National Institute of Scientific Research – INRS -, Canada)

Session Chair: *Dr. Thomas Kunz (Carleton University, Canada)*

12:15 – 12:15

TIPOT Demonstration - Zoom

Link : <https://cmaisonneuve.zoom.us/my/isncc2020>

13:15 – 14:15

Keynote 9

"IPv6-based New Internet empowering Super IoT, 5G, Blockchain and Cloud Computing"

Dr. Latif Ladid (ETSI IPv6 Industry Standard Group, Luxembourg)

Session Chair: *Dr. Hamid Mcheick (University of Quebec at Chicoutimi, Canada)*

Technical Sessions

8:15 – 9:45

C1- Systems and Web Applications Security

Zoom Link : <https://cmaisonneuve.zoom.us/j/94944428447>

Session Chair: *Dr. Mohamed Reda Bouadjenek (University of Toronto, Canada)*

1570619813– [Novel high secure distributed e-mail system,](#)

Noriharu Miyaho (Tokyo Denki University & Japan, Japan); Shunki Shinohara (Tokyo Denki University, Japan)

[See Presentation](#)

1570619432– [Asynchronous Forensic Investigative Approach to Recover Deleted Data from Instant Messaging Applications,](#)

Fahad Salamh, Umit Karabiyik and Marcus K Rogers (Purdue University, USA)

[See Presentation](#)

1570619434– [LCA-ABE: Lightweight Context-Aware Encryption for Android Applications,](#)

Saad Inshi (ETS, Canada); Rasel Chowdhury (École de Technologie Supérieure, Canada); Mahdi Elarbi and Hakima Ould-Slimane (ETS, Canada); Chamseddine Talhi (École de Technologie Supérieure, Canada)

[See Presentation](#)

1570634520–[A Detour Strategy for Visiting Phishing URLs Based on Dynamic DNS Response Policy Zone,](#)

Yong Jin and Masahiko Tomoishi (Tokyo Institute of Technology, Japan); Nariyoshi Yamai (Tokyo University of Agriculture and Technology, Japan)

[See Presentation](#)

1570631113- [Improving WebRTC Security via Blockchain Based Smart Contracts,](#)

Berat Yilmaz and Ertugrul Barak (ASELSAN Inc., Turkey); Suat Ozdemir (Gazi University, Turkey)

[See Presentation](#)

1570653678– [Lightweight cryptographic URLLC for 5G-V2X,](#)

Iqra Mustafa (NCTU, HSINCHU, Taiwan); ChingYao Huang (National Chiao Tung U., Taiwan)

[See Presentation](#)

C2- Satellite communications and Networking II

Zoom Link : <https://cmaisonneuve.zoom.us/j/91767323892>

Session Chair: *Dr. Nawel Zangar (ESIEE PARIS, France)*

1570655096– [Analysis of Interference Mitigation between Earth Station – High Throughput Satellite towards 5G Terrestrial Network in 28 GHz Co-channel Frequency,](#)

Nico Febry Yoshua, Anna Situmorang and Dadang Gunawan (Universitas Indonesia, Indonesia)

[See Presentation](#)

1570658917– [Resilience Improvements for Space-Based Radio Frequency Machine Learning](#),

Lauren J Wong, Emily Altland, Joshua Detwiler, Paolo Fermin, Julia Mahon Kuzin, Nathan Moeliono and Abdelrahman Said Abdalla (Virginia Tech Hume Center, USA); William C Headley (Virginia Tech & Hume Center, USA); Alan J Michaels (Virginia Tech & Hume Center for National Security and Technology, USA)

[See Presentation](#)

1570633795– [Distance Aware Radio Planning for SDN Based 5G-Satellite Network](#),

Nawel Zangar (ESIEE PARIS, France); Marwen Abdennebi (L2TI Laboratory, University of Paris Nord, France); Saloua Hendaoui (Sup'com, Tunisia)

[See Presentation](#)

1570619330– [Solutions to Data Reception with Improved Blind Source Separation in Satellite Communications](#),

Li Chengjie (Southwest Minzu University, China); Lidong Zhu (University of Electronic Science and Technology of China, China); Zhongqiang Luo (Sichuan University of Science & Engineering, China); Zhen Zhang (Sichuan University, China)

[See Presentation](#)

1570630799– [Enabling an efficient satellite-terrestrial hybrid transport service through a QUIC-based proxy function](#),

Michele Luglio and Mattia Quadrini (University of Rome Tor Vergata – Dip. Ing. Elettronica, Italy); Simon Pietro Romano (University of Napoli Federico II, Italy); Cesare Roseti and Francesco Zampognaro (University of Rome Tor Vergata, Italy)

[See Presentation](#)

C3- Signals and Communication Systems

Zoom Link : <https://cmaisonneuve.zoom.us/j/95868314911>

Session Chair: *Dr. Alain Richard Ndjiongue (University of Johannesburg, South Africa)*

1570622958– [Artificial Noise-aided Spatial and Directional Modulation Systems for Secure Transmission,](#)

Yue Xiao, Hongyan Zhang and Bin Fu (University of Electronic Science and Technology of China, China); Xiaotian Zhou (The No. 54 Research Institute of CETC, China)

[See Presentation](#)

1570654237– [CP-Less MIMO Discrete Fourier Transform Spread OFDM,](#)

Md Mainul Islam Mamun (University of Missouri-Kansas City, USA); Deep Medhi (University of Missouri-Kansas City & NSF, USA); Cory Beard (University of Missouri-Kansas City, USA)

[See Presentation](#)

1570652375– [The Zenith Scheme: A Novel Modulation Technique for MIMO OFDM Systems with 2D-FFT,](#)

Zhenghao Zhang (Florida State University, USA)

[See Presentation](#)

1570622962– [Secure Hybrid Analog and Digital Precoding for Massive MIMO Systems,](#)

Shan Luan and Yan Zhang (China Academy of Space Technology, China); Hongyan Zhang, Yanping Xiao, Yue Xiao and Bin Fu (University of Electronic Science and Technology of China, China)

[See Presentation](#)

1570650524– [Outage Probability of a CSK Transmission in Visible Light Communications Systems,](#)

Alain Richard Ndjiongue (University of Johannesburg, South Africa); Telex M. N. Ngatched (Memorial University of Newfoundland, Canada)

[See Presentation](#)

C4- Applications of AI/ML in Smart Cities

Zoom Link : <https://cmaisonneuve.zoom.us/j/96604935708>

Session Chair: *Dr. Wadii Boulila (National School of Computer Sciences, Tunisia)*

1570619405– [Machine Learning-based Modelling for Museum Visitations Prediction,](#)

Norman Yap (University of Auckland, New Zealand); Mingwei Gong (Mount Royal University, Canada); Ranesh Kumar Naha (University of Tasmania, Australia); Aniket Mahanti (University of Auckland, New Zealand)

[See Presentation](#)

1570622989– [Intelligent Fruit Maturity Assessment Platform Using Convolutional Neural Network: IFMAP,](#)

Jihene Rezgui, Thomas Trépanier, David Génois, Hervé Claden and Amasten Ameziani (College Maisonneuve, Canada)

[See Presentation](#)

1570628601– [A Machine-Learning based Approach to Support Academic Decision-Making at Higher Educational Institutions,](#)

Muhib Al-kmali and Hamza Sameer (Taibah University, Saudi Arabia); Wadii Boulila (National School of Computer Sciences, Tunisia); Mohammed Al-Sarem (Taibah University, Saudi Arabia), Anmar Abuhamdah (Taibah University, Saudi Arabia)

[See Presentation](#)

1570672843– [Real-Time Tracking of Aircrafts in Crowdsourced Air Traffic Networks and Rough Localization Estimates,](#)

Abderrazek Chaka Bannour (University of Tunis, Tunisia), Rim Moussa (LaTICE, Tunisia), Tarek Bejaoui (University of Carthage, Tunisia)

[See Presentation](#)

1570646202– [Mushroom Demand Prediction Using Machine Learning Algorithms,](#)

Md Al Maruf and Akramul Azim (Ontario Tech University, Canada); Sourojit Mukherjee (NIT Durgapur, India)

[See Presentation](#)

C5- ML For Safety, Trust and Security

Zoom Link : <https://cmaisonneuve.zoom.us/j/95467478329>

Session Chair: *Dr. Shaimaa Ali (University of Western Ontario, Canada)*

1570622683 – Empirical Comparison of Machine Learning Algorithms for Mitigating Power Systems Intrusion Attacks,

Oyenyi Alimi and Khmaies Ouahada (University of Johannesburg, South Africa); Adnan Abu-Mahfouz (CSIR Meraka Institute, South Africa); Kuburat Oyeranti Adefemi (University of Johannesburg, South Africa)

[See Presentation](#)

1570653278 – Evaluation of Adversarial Training on Different Types of Neural Networks in Deep Learning-based IDSs,

Rana Abou Khamis and Ashraf Matrawy (Carleton University, Canada)

[See Presentation](#)

1570652493 – Truth Prediction by Weakly Connected Agents in Social Networks Using Online Learning,

Olusola Tolulope Odeyomi (Wichita State University, USA)

[See Presentation](#)

1570631051 – Construction Safety Surveillance Using Machine Learning,

Ruksin Kamal, Ajai John Chemmanam and Bijoy A. Jose (Cochin University of Science and Technology, India); Sunil Mathews and Eldho Varghese (KITCO, India)

[See Presentation](#)

1570651732 – Intelligent Frames for occupants safety in Automobiles,

Satyam Pandey, Vipul Shrikant Deshpande and Manoj Prem Siddaiah Mahadevaiah (FH Dortmund, Germany)

[See Presentation](#)

C6- Edge, Cloud and Social Computing and Networking II

Zoom Link : <https://cmaisonneuve.zoom.us/j/95840460377>

Session Chair: *Dr. Hamid Mcheick (University of Quebec at Chicoutimi, Canada)*

1570620675- [A Web Client Perspective on IP Geolocation Accuracy,](#)

Joel Sommers (Colgate University, USA)

[See Presentation](#)

1570619356- [Using Execution Profiles to Identify Process Behavior Classes,](#)

Arnav Bhandari, Katherine Juarez and Errin Fulp (Wake Forest University, USA)

[See Presentation](#)

1570630050- [Multiple Attributes K-Means Clustering for Elastic Cloud Model,](#)

Tariq Daradkeh, Anjali Agarwal and Yanal Alahmad (Concordia University, Canada)

[See Presentation](#)

1570630725- [Optimizing Virtual Machine Migration in Multi-Clouds,](#)

A B M Bodrul Alam (Queen's University, Canada); Talal Halabi (The University of Winnipeg, Canada);
Anwar Haque (Western Ontario, Canada); Mohammad Zulkernine (Queen's University, Canada)

[See Presentation](#)

1570630929- [Programmability of Policy Control at the Edge of the Mobile Network,](#)

Evelina Pencheva, Ivaylo Asenov, Ivaylo Atanasov and Vencislav Trifonov (Technical University of
Sofia, Bulgaria)

[See Presentation](#)

1570631234- [Prototype Development of Face and Speaker Recognitions based on Edge Computing,](#)

Pan Yuxuan, Peng Xiaowen, Xuexian Lin and Minghua Xia (Sun Yat-sen University, China)

[See Presentation](#)

1570656679- [Bayesian Joint Synchronization and Localization Based on Asymmetric Time-stamp
Exchange,](#)

Meysam Goodarzi (Humboldt University of Berlin & IHP – Leibniz-Institut für Innovative
Mikroelektronik, Germany); Nebojsa Maletic and Jesús Gutiérrez (IHP – Leibniz-Institut für Innovative
Mikroelektronik, Germany); Eckhard Grass (IHP & Humboldt-University Berlin, Germany)

[See Presentation](#)

C7- BlockChain and Finance Technology

Zoom Link : <https://cmaisonneuve.zoom.us/j/94554913890>

Session Chair: *Dr. Imen Latrous (University of Quebec at Chicoutimi, Canada)*

1570631201 – [Decentrally-Consented-Server-Based Blockchain System for Universal Types of Data,](#)

Miraz Uz Zaman and Manki Min (Louisiana Tech University, USA)

[See Presentation](#)

1570622689 – [A Decentralized Tree-based Algorithm for Reliable Blockchain Communications,](#)

Chih-Hao Lin and Wen-Yuan Chen (Chung Yuan Christian University, Taiwan); Ping-Sheng Lin (University of Waterloo, Canada)

[See Presentation](#)

1570622718 – [BlockHR – A Blockchain-based Healthcare Records Management Framework: Performance Evaluation and Comparison with Client/Server Architecture,](#)

Leila Ismail (UAE University & Founder and Director to the High Performance and Grid/Cloud Computing Research Laboratory, United Arab Emirates)

[See Presentation](#)

1570633692 – [PubChain: A Decentralized Open-Access Publication Platform with Participants Incentivized by Blockchain Technology,](#)

Taotao Wang (Shenzhen University, China); Soung Chang Liew (The Chinese University of Hong Kong, Hong Kong); Shengli Zhang (Shenzhen University, China)

[See Presentation](#)

1570635634 – [Enhancing the Security and Privacy of Self-Sovereign Identities on Hyperledger Indy Blockchain,](#)

Manas Pratim Bhattacharya (Concordia University of Edmonton, Canada)

[See Presentation](#)

1570649789– [The Security Ingredients for Correct and Byzantine Fault-tolerant Blockchain Consensus Algorithms,](#)

Amani Altarawneh (University of Tennessee At Chattanooga, USA); Anthony Skjellum (University of Tennessee at Chattanooga, USA)

[See Presentation](#)

C8- Advances in Communications and Networking

Zoom Link : <https://cmaisonneuve.zoom.us/j/95830623914>

Session Chair:*Dr. Cesare Roseti (University of Rome Tor Vergata, Italy)*

1570619368– [Capacity Heat Maps for Millimeter Waves,](#)

Gabriela de Carvalho (Universidade Federal de Campina Grande, Brazil); Marcelo S. Alencar (Federal University of Campina Grande & Institute for Advanced Studies in Communications, Brazil); Raissa Rocha (Universidade Federal de Sergipe, Brazil)

[See Presentation](#)

1570619362– [Secrecy Performance of AF/DF relaying in NOMA Systems using Average and Instantaneous Channel gain for users' ranking,](#)

Nesrine Zaghdoud (SUP'COM, Tunisia); Adel Ben Mnaouer (Canadian University Dubai & Faculty of Engineering, Applied Science and Technology, United Arab Emirates); Wided Hadjalouane (COSIM Research Lab, Tunisia); Hatem Boujemaa (SupCom, Tunisia); Farid Touati (Qatar University, Qatar)

[See Presentation](#)

1570639328– [The Design of Logging While Drilling's Data Acquisition & Processing System based on High Data Rate Miller code,](#)

Yao Liang, Xiaodong Ju, Meishan Wang, Peng Liu, Chuanwei Li and Li Ma (China University of Petroleum(Beijing), China)

[See Presentation](#)

1570627756- [Low-power Concepts for FPGAs in Applications with limited Energy Resources,](#)

Karol Niewiadomski and Dietmar Tutsch (University of Wuppertal, Germany)

[See Presentation](#)

1570631222– [Frequency Selective CMOS RF-to-DC Rectifier for Wirelessly Powering and RFID Applications,](#)

Nima Souzandeh (INRS & EMT, Canada); Mansoor Dashti Ardakani and Serioja Ovidiu Tatu (INRS-EMT, Canada); Sonia Aissa (INRS, University of Quebec, Canada)

[See Presentation](#)

14:30 – 16:00

C9- Networks Security

Zoom Link : <https://cmaisonneuve.zoom.us/j/94816377431>

Session Chair: *Dr. Ahmed Meddahi (IMT Lille Douai, France)*

1570616665– [Risk-based Trust Evaluation Model for VANETs,](#)

Rasha Atwah, Paola Flocchini and Amiya Nayak (University of Ottawa, Canada)

[See Presentation](#)

1570618538– [Information security risk assessment based on decomposition probability via Bayesian Network,](#)

P. Yermalovich (Université Laval & Revenu Québec, Canada); Mohamed Mejri (Laval University, Canada)

[See Presentation](#)

1570652722– [Detecting Abnormal Traffic in Large-Scale Networks,](#)

Mahmoud Elsayed, Nhien-An Le-Khac, Soumyabrata Dev and Anca Delia Jurcut (University College Dublin, Ireland)

[See Presentation](#)

1570651931– [Botnets and their detection techniques,](#)

Ahmed Shafee (Tennessee Tech University, USA)

[See Presentation](#)

1570619352– [Cluster Analysis of Passive DNS Features for Identifying Domain Shadowing Infrastructure,](#)

Nolan Hamilton (Wake Forest University, USA); Eddie Allan (Cisco Systems Inc., USA); Errin Fulp (Wake Forest University, USA)

[See Presentation](#)

C10- QoS Provisioning for M2M and Wireless Communications

Zoom Link : <https://cmaisonneuve.zoom.us/j/93042347894>

Session Chair: *Dr. Ramiro Liscano (University of Ontario Institute of Technology, Canada)*

1570646188– [LTE Base Station Congestion Mitigation using Game Theory and Radio Resource Allocation Techniques,](#)

Avirop Ghosh (Royal Melbourne Institute of Technology, Australia); Karina Mabell Gomez and Sithamparanathan Kandeepan (RMIT University, Australia)

[See Presentation](#)

1570631075– [Resource Management Based on Reinforcement Learning for D2D Communication in Cellular Networks,](#)

Amamer Saied, Dongyu Qiu and Mahmoud Swessi (Concordia University, Canada)

[See Presentation](#)

1570619427– [Optimized Application Driven Scheduling for Clustered WSN,](#)

Hossein Amirinia (OntarioTech University, Canada); Ramiro Liscano (University of Ontario Institute of Technology, Canada)

[See Presentation](#)

1570630994– [A Collision Avoiding Packet Scheduling and Energy-Efficient Routing Technique for Video Wireless Sensor Networks,](#)

Nouman Bashir (Université Sorbonne Paris Nord & Institute Galilee, France) ; Saadi Boudjit (University of Paris 13, France)

[See Presentation](#)

1570619436- [Performance of Cell-Free Systems in Generalized Fading Channels,](#)

Danilo Almeida (UFMG, Brazil); Marcelo S. Alencar (Federal University of Campina Grande & Institute for Advanced Studies in Communications, Brazil); Wamberto Queiroz and Rafael M. Duarte (Universidade Federal de Campina Grande, Brazil); Waslon Lopes (Universidade Federal da Paraíba & IECOM – Institute for Advanced Studies in Communications, Brazil); Hugerles Silva (Universidade Federal de Campina Grande, Brazil)

[See Presentation](#)

1570619422– [Resource Allocation for Device-to-Device \(D2D\) Communications of Uplink Multi-Cell Networks,](#)

Amamer Saied and Dongyu Qiu (Concordia University, Canada)

[See Presentation](#)

C11- Smart Communications and Signals

Zoom Link : <https://cmaisonneuve.zoom.us/j/92083667323>

Session Chair:*Dr. Alain Richard Ndjiongue (University of Johannesburg, South Africa)*

1570658934– [Multiuser Visible Light Communication System using Hybrid OFDM-PWM,](#)

Affan Affan (University of Louisville, USA); Usama Khan (COMSATS University Islamabad, Pakistan); Hafiz Asif (Sultan Qaboos University, Oman); Kaamran Raahemifar (Sultan Qaboos University, Bahrain)

[See Presentation](#)

1570653792– [Multiple Sequential Constraint Removal Algorithm For Channel Estimation In Vehicular Environment,](#)

Soheyb Ribouh (Polytechnic University of the Hauts-de-France (UPHF), France)

[See Presentation](#)

1570622655– [Machine to Machine Based on Visible Light Communication](#),

Rodrique Chi Fon, Alain Richard Ndjiongue and Khmaies Ouahada (University of Johannesburg, South Africa)

[See Presentation](#)

1570653410– [The Visual Quality of Teleoperated Driving Scenarios – How good is good enough?](#),

Stefan Neumeier (Technische Hochschule Ingolstadt & Technische Universität München, Germany);
Simon Stapf and Christian Facchi (Technische Hochschule Ingolstadt, Germany)

[See Presentation](#)

1570631184– [Modeling LoRa: a Complex Envelope Approach](#),

Luz Enith Marquez (Institución Universitaria ITSA & Universidad del Norte, Colombia)

[See Presentation](#)

C12- Advances in Engineering for Smart Cities & Applications II

Zoom Link : <https://cmaisonneuve.zoom.us/j/94889023679>

Session Chair: *Dr. Serguei A. Mokhov (Concordia University, Canada)*

1570619402– [Game Theoretic Approach for a Multi-Mode Transportation in Smart Cities](#),

Mohammed Bin Hariz (University of Ottawa, Canada); Dhaou Said (University of Ottawa & INTERLAB Research Laboratory, Canada); Hussein Mouftah (University of Ottawa, Canada)

[See Presentation](#)

1570656308– [Congestion Aware Data Collection with Mobile Sinks in Smart City](#),

Fairouz Chahbour (Boumerdes University, Algeria); Doukha Zouina and Moussaoui Samira (USTHB, Algeria); Guerroumi Mohamed (USTHB, Algiers, Algeria)

[See Presentation](#)

1570631453– [Development of Real-time Smart City Mapping Utilizing Game Engines](#),

Samuel Tucker Clark (University Of Tennessee at Chattanooga, USA); Evan Brock (University of Tennessee at Chattanooga, USA); Dalei Wu (The University of Tennessee at Chattanooga, USA); Yu Liang (University of Tennessee at Chattanooga, USA)

[See Presentation](#)

1570627082– [Autonomous Learning Intelligent Vehicles Engineering \(ALIVE\)](#),

Jihene Rezgui (College Maisonneuve, Canada) ; Émile Gagné and Guillaume Blain (Collège de Maisonneuve, Canada)

[See Presentation](#)

1570623000– [OpenISS IoT Camera Simulation Environment for Real-time IoT Forensics and Incident Response](#),

Serguei A. Mokhov, Rostislav Axamitnyy and Alexander Aric (Concordia University, Canada)

[See Presentation](#)

1570653780– [A data fusion algorithm for clinically relevant anomaly detection in remote health monitoring](#),

Hugo de Mello Dantas and Claudio M. Farias (Universidade Federal do Rio de Janeiro, Brazil)

[See Presentation](#)

C13- Anomaly Detection and Security

Zoom Link : <https://cmaisonneuve.zoom.us/j/93342661650>

Session Chair: *Dr. Abdelkader Ouda (University of Western Ontario, Canada)*

1570653677– [Unmasking Magnet, a Novel Malware on Facebook](#),

Mohammad Reza Faghani and Uyen Trang Nguyen (York University, Canada)

[See Presentation](#)

1570653787– [P-Code Based Classification to Detect Malicious VBA Macro](#),

Simon Huneault-LeBlanc (Canada); Chamseddine Talhi (École de Technologie Supérieure, Canada)

[See Presentation](#)

1570638157– [Vulnerable Road Users Detection based on Convolutional Neural Networks,](#)

Abdelhamid Mammeri, Abdul Jabbar Siddiqui, Yiheng Zhao and Barry Pekilis (National Research Council Canada, Canada)

[See Presentation](#)

1570619506– [An Effective Hybrid Anomaly Detection System Based on Mixture Models,](#)

Yogesh P Pawar, Nuha Zamzami and Nizar Bouguila (Concordia University, Canada)

[See Presentation](#)

1570622800– [A Lightweight Deep Neural Model for SMS Spam Detection,](#)

Feng Wei and Uyen Trang Nguyen (York University, Canada)

[See Presentation](#)

1570631002– [AltCC: Alternating Clustering and Classification for Batch Analysis of Malware Behavior,](#)

Sahar M. Ghanem (Alexandria University, Egypt)

[See Presentation](#)